

Article number: 201226020

Description: E+G Magnets with bore GN 50.4-HF-20-6-4,3
Hard ferrite - 200° C, 27N

Measures

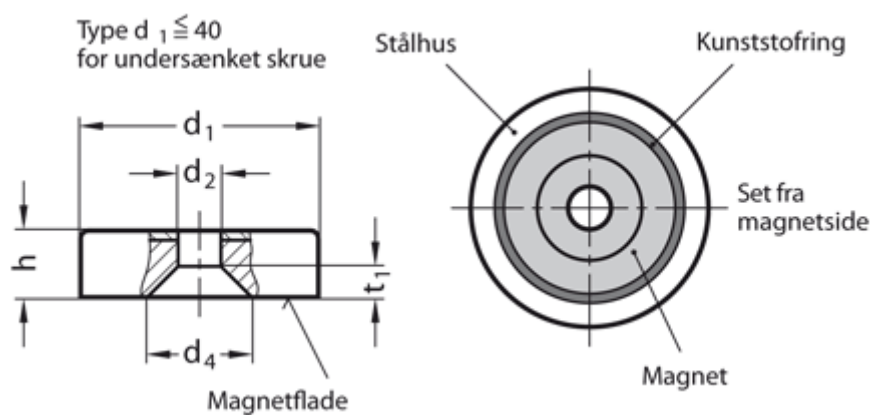

d_1 = $20 \pm 0,1$

d_2 = 4.1

d_4 = 9.4

h = $6 + 0,2/-0,1$

Holding force N = 27

Material = HF hard ferrite - 200°.C

t = 2.7